



## 1600W 36cm Electric Rotary Lawnmower **WEER36**

1938123002

## 1800W 40cm Electric Rotary Lawnmower **WEER40**

1938124003

# en - Original Instructions

### **ASSEMBLY REQUIRED**

**Save these instructions**  
**Sales & Support: 01793 333212**

Before use please read & understand this manual; paying particular attention to the safety instructions before use.

Incorrect use of the product could put the operator or machine in danger.

Whilst every effort has been made to ensure the accuracy of information contained in this manual, our policy of continuous improvement determines the right to make modifications without prior warning.

Images are used for illustration purposes only.



## INSTRUCTION MANUAL



27 Jan 2022

---

### *Copyright Notice*

Copyright © Handy Distribution

Permission is granted to reproduce this publication for personal & educational use only.

Commercial copying, redistribution, hiring or lending is prohibited.

No part of this publication may be stored in a retrieval system or transmitted in any other form or means without written permission from Handy Distribution.

In all cases this copyright notice must remain intact.

## **CONTENTS**

**SPECIFICATION**

**IMPORTANT INFORMATION**

**GENERAL SAFETY INSTRUCTIONS**

**KNOW YOUR MACHINE**

**SET UP & PREPARATION FOR OPERATION**

**ASSEMBLY**

**OPERATION**

**ELECTRICAL CONNECTION**

**MAINTENANCE, CLEANING & STORAGE**

**TROUBLE SHOOTING**

**PARTS DIAGRAM & LIST**

**DECLARATION OF CONFORMITY**

**WARRANTY**

### **ASSEMBLY IS REQUIRED - MINIMUM TWO PERSONS**

- This product requires assembly before use.
- See "Assembly" section for instructions.
- Because of the weight and/or size of the machine, it is recommended that another adult is present to assist with the assembly.
- Inspect all components closely upon receipt to make sure no items are missing or damaged.



#### **WARNING**

**Read this instruction manual carefully before operating this machine. Make sure that you are familiar with the controls and properly operate the machine. Following these instructions can reduce the risk of personal injury.**



## INSTRUCTION MANUAL

### SPECIFICATION

Model No.	WEER36	WEER40
Product No.	1938123002	1938124003
Motor	230-240V~ 50Hz	
Rated Power	1600W	1800W
No Load Speed	3700rpm	
Cutting Width	36cm	40cm
Height of Cut	20-70mm	
Height Adjustments	5	
Collector Capacity	45L	50L
Cable Length	10m	15m
Sound Power Level L <sub>WA</sub> :	96 dB(A)	
Vibration	1.47m/s <sup>2</sup>	2.5m/s <sup>2</sup>
Protection	IPX4 	
Weight:	11.5kg	12.7kg

**The manufacturer reserves the right to change the product specification and livery according to continued product improvements.**

Consistent with our policy of continuous improvement, The Handy reserves the right to change the design and configuration of any of its products without notice or obligation. Therefore, please treat the text and images in this manual for illustrative purposes only. They may in no case serve as a basis for any legal claim.

**If you require any assistance with regards to the contents or operation of your machine, please contact us:**

**Tel: 01793 333212, option 2**

**Email: [customerservice@handydistribution.co.uk](mailto:customerservice@handydistribution.co.uk)**

**Opening Hours Weekdays: (CLOSED WEEKENDS & BANK HOLIDAYS)**

**February to October 8:00am - 5:00pm - November to January 8:30am - 5:00pm**



This symbol on the product or on its packaging indicates that this product may not be treated as household waste. Instead, it shall be handed over to the applicable collection point for the recycling of electrical and electronic equipment.

For more detailed information about recycling of this product, please contact your local council office, your household waste disposal service or shop where you purchased the product.

## IMPORTANT INFORMATION

### INTENDED USAGE

The basic version of the equipment is a lawnmower intended for private use, i.e. for use in home and domestic gardening environments. It is designed for cutting natural grass in from small sized gardens. Any use not expressly permitted in this manual may damage lawnmower and pose a serious danger to the user.

### DO CUT ANY OTHER FOILAGE OR MATERIAL.

The shredder is for private use only, whose annual operating time generally does not exceed 50 hours. Public facilities, sporting facilities and agricultural / forestry applications are excluded. Not to be used to trim bushes, hedges and shrubs, to cut or shred climbing plants or lawns on roof gardens or in balcony boxes or to clean footpaths, nor must it be used as a chopper for shredding tree or hedge cuttings.

Furthermore, the lawn mower must not be used as a cultivator or to level off uneven areas of ground, e.g. molehills.

Please read this entire manual prior to operating the equipment. It instructs you how to safely and easily set up, operate and maintain your machine. Please be sure that you and any other persons who will operate the machine, always carefully follow the recommended safety practices. Failure to do so could result in personal injury or property damage.

### IF NOT USED PROPERLY THIS MACHINE CAN BE DANGEROUS!

This machine can cause serious injury to the operator and others, the warning and safety instructions must be followed to ensure reasonable safety and efficiency in using this product. The operator is responsible for following the warning and safety instructions in this manual and on the machine. Never use the product unless the components are correctly positioned and operational.

### TRAINING

Read the instructions carefully: Be familiar with the controls and the proper use of the equipment.

Never allow children or people unfamiliar with these instructions to use the product.

Local regulations can restrict the age of the operator.

Keep in mind that the operator or user is responsible for accidents or hazards involving the machine that occur to other people or their property.



#### WARNING

**The operator or user is responsible for accidents and injury or damage to third parties.**





















**The equipment is allowed to be used only for its prescribed purpose. Any other use is deemed to be a case of misuse. The user/operator and not the manufacturer will be liable for any damage or injuries of any kind resulting from such misuse. Please note that our equipment has not been designed for use in commercial, trade or industrial applications. Our warranty will be 90 days from the original date of sale for commercial, trade or industrial businesses or for equivalent purposes.**



# INSTRUCTION MANUAL

## GENERAL SAFETY INSTRUCTIONS

It is important that you read and understand the owner's manual and labels affixed to the machine. Learn its application and limitations as well as the specific potential hazards. Retain these instructions for future reference. The operator is responsible for following the warnings & instructions in this manual and on the product.

	<p>Read &amp; understand the instruction manual before using the machine. Failure to follow instructions could result in death or serious injury. Please keep in a safe place for future reference.</p>	 	<p>Whenever the machine is in use, safety goggles or glasses must be worn to safeguard against flying objects. Hearing protection must also be used to protect the operators hearing. Face masks are also recommended to avoid inhalation of debris.</p>
	<p>Remove the electrical plug from the power supply before any maintenance, repair, cleaning or if the power cable is damaged.</p>	 	<p>Always wear gloves to protect your hands. Wear foot protection or sensible shoes when using the machine. Steel-toed shoes are recommended</p>
	<p><b>DANGER</b> Keep all bystanders &amp; animals away from the machine during operation. If approached, stop the machine immediately.</p>		<p><b>DANGER — THROWN DEBRIS</b> Remove objects that can be thrown by the machine in any direction.</p>
	<p><b>IMPORTANT NOTE!</b> Risk of injury due to rotating blade! Keep hands and feet outside of the openings when the machine is running.</p>		<p>Keep guards in place and in working order. Replace damaged, missing, or failed parts before operating.</p>
	<p>Do not misuse as a step or climb upon the machine.</p>		<p>Do not expose to rain or damp conditions.</p>
	<p>Be careful when using on slopes. Do not operate on inclines greater than 15°. It is advised to cut across the incline.</p>		<p>Class II, double insulation</p>
	<p>Safety alert symbol. Used to alert you to potential personal injury hazards. Obey all safety messages that follow this symbol to avoid possible injury.</p>	 <p><b>DANGER</b></p>	<p>Indicates an imminently hazardous situation which, if not avoided, will result in serious injury</p>
 <p><b>WARNING</b></p>	<p>Indicates a potentially hazardous situation which, if not avoided, could result in serious injury</p>	 <p><b>CAUTION</b></p>	<p>Indicates a potentially hazardous situation which, if not avoided, may result in minor or moderate injury.</p>
<p><b>CAUTION</b></p>	<p>Used without the safety alert symbol indicates a potentially hazardous situation which, if not avoided, may result in property damage.</p>		<p>Noise Level - See label on machine</p>
	<p>CE Marking - the product meets demand and regulations set by the EU</p>		

## IMPORTANT SAFETY WARNINGS



### WARNING

**Before you put the machine into operation, you must read this instruction manual.**

**When using this machine, observe the following safety instructions to remove the risk of personal injury or material damage. Please also observe the special safety instructions in the respective chapters. Where applicable, follow the legal directives or regulations for the prevention of accidents in relation to the use of this machine.**

**When using electric tools, basic safety precautions, including the following, should always be followed to reduce the risk of serious personal injury and/or damage to the unit.**

## GENERAL OPERATION

1. Read this instruction manual carefully in its entirety before attempting to assemble this machine. Read, understand, and follow all instructions on the machine and in the manual(s) before operation. Keep this manual in a safe place for future and regular reference and for ordering replacement parts.
2. Be completely familiar with the controls and the proper use of this machine before operating it.
3. This machine is a precision piece of power equipment, not a plaything. Therefore, always exercise extreme caution. This machine has been designed to perform one job: compacting fibrous and wood-related materials. Do not use it for any other purpose.
4. This appliance is not intended for use by persons (including children) with reduced physical, sensory or mental capabilities, or lack of experience and knowledge, unless they have been given supervision or instruction concerning use of the appliance by a person responsible for their safety.
5. Never allow children under 16 years of age to operate this machine. Children 16 and over should read and understand the instructions and safe operation practices in this manual and on the machine and should be trained and always supervised by an adult.
6. Only responsible individuals who are familiar with these rules of safe operation should be allowed to use this machine.
7. Thoroughly inspect the area where the equipment is to be used. Remove all stones, sticks, wire, bones, toys, and other foreign objects, which could be tripped over or picked up and placed into the shredder. Foreign objects can cause serious damage to the machine or increases the chances of personal injury.
8. Stay in operator zone behind operation panel and handles and keep children, bystanders, helpers, and pets at least 20 metres from shredder while it is in operation. Stop machine if anyone enters area.
9. Always wear safety glasses or safety goggles during operation and while performing an adjustment or repair to protect your eyes. Thrown objects which ricochet can cause serious injury to the eyes.
10. Wear sturdy, rough-soled work shoes and close-fitting trousers and shirts. Shirts and trousers that cover the arms and legs and steel-toed shoes are recommended. Never operate this machine in bare feet, sandals, slippery or light-weight (e.g. canvas) shoes.
11. Do not put hands or feet near or into rotating parts. Always keep clear of input and discharge areas, as the rotating blade can cause injury.
12. Never operate the lawnmower without proper shields, guards, control lever or other safety protective devices in place and working.
13. Never operate the lawnmower with damaged safety devices. Failure to do so, can result in personal injury.
14. Do not operate the lawnmower while under the influence of alcohol or drugs.
15. Never attempt to bypass its operation safety devices. Doing so makes the safety device inoperative and may result in personal injury through contact with the rotating blade.
16. Never operate the shredder in wet grass. Always be sure of your footing. A slip and fall can cause serious personal injury. Plus cutting in wet grass can cause excessive build-up of cut grass around the cutting deck and cause issues with your collection and also extra pressure on the machines motor.
17. Operate only in daylight or good artificial light. Walk, never run when around the machine.
18. Do not use the machine on a paved, graveled area, which could be damaged by ejected material
19. If the machine starts to vibrate abnormally, stop the motor, and check immediately for the cause. Vibration is generally a warning of trouble.
20. Shut the motor off and wait until the blade comes to a complete stop before cleaning the discharge area.



## INSTRUCTION MANUAL

The blade continues to rotate for a few seconds after you release the trigger. Never place any part of the body in the cutting area until you are sure the blade has stopped rotating and the electrical plug has been removed from the power source and contact cannot be made between the two.

21. Never operate the lawnmower without proper shields or other safety protective devices in place and working. Never operate with damaged safety devices. Failure to do so can result in personal injury.
22. Only use parts and accessories made for this machine by the manufacturer. Failure to do so can result in personal injury.
23. If situations occur which are not covered in this manual, use care and good judgement. Contact your nearest Approved Service Dealer for assistance

### SLOPE OPERATION

Slopes are a major factor related to slip and fall accidents, which can result in severe injury. Operation on slopes requires extra caution. If you feel uneasy on a slope, or it is greater than 15° degrees, do not operate on it.

#### Do:

1. Cut across an incline, not up or down.
2. Exercise extreme caution when changing direction on slopes.
3. Watch for holes, ruts, rocks, hidden objects, or bumps which can cause you to slip or trip. Tall grass can hide obstacles.
4. Always be sure of your footing. A slip and fall can cause serious personal injury.

#### Do Not:

1. Do not operate near drop-offs, ditches, or embankments, you could lose your footing or balance.
2. Do not operate on slopes greater than 15° degrees.
3. Do not operate on wet grass. Unstable footing could cause slipping.

### CHILDREN

Tragic accidents can occur if the operator is not alert to the presence of children. Children are often attracted to the machine and the activity. They do not understand the dangers. Never assume that children will remain where you last saw them.

1. Keep children out of the operating area and under care of a responsible adult other than the operator.
2. Be alert and turn the machine off if a child enters the area.
3. Before and while moving backwards, look behind and down for small children.
4. Never allow children under 16 years of age to operate this machine. Children 16 and over should read and understand the instructions and safe operation practices in this manual and on the machine and be trained and supervised by an adult.

### SERVICE

#### General Service:

1. Before cleaning, repairing, or inspecting, make certain the blade and all moving parts have stopped. Disconnect the electrical plug from the power source to prevent unintended starting.
2. Check the blade at frequent intervals for proper tightness. Also, visually inspect for damage. Replace with the original equipment manufacturer's (O.E.M.) parts only, listed in this manual. "Use of parts which do not meet the original equipment specifications may lead to improper performance and compromise safety!"
3. Keep all nuts, bolts, and screws tight to be sure the equipment is in safe working condition.
4. Never tamper with safety devices. Check the correct operation regularly.
5. After striking a foreign object, stop the motor, disconnect the electrical plug from the power source. Thoroughly inspect the machine for any damage. Repair the damage before starting and operating the machine.
6. Components, guards and shields are subject to wear and damage which could expose moving parts or allow objects to be thrown. For safety protection, frequently check components and replace immediately with original equipment manufacturers (O.E.M.) parts only, listed in this manual. "Use of parts which do not meet the original equipment specifications may lead to improper performance and compromise safety!"
7. Do not change the motor's settings. The motor has been set for the maximum safe operating speed.
8. Maintain or replace safety and instruction labels, as necessary.
9. Observe proper disposal laws and regulations. Improper disposal of fluids and materials can harm the environment.



### **DO NOT MODIFY THE MOTOR**

To avoid serious injury or death, do not modify the motor in any way. Tampering with the motor settings can cause it to operate at unsafe speeds and lead to premature failure. Never tamper with factory settings of the motor. Please refer to this manual, before undertaking any inspection, repair, or maintenance.

### **ELECTRICAL SAFETY**



**Always check that the power supply corresponds to the voltage on the rating plate.**

1. Power tool electrical plugs must match the outlet. Never modify the plug in any way. Do not use adapter plugs with earthed power tools. Unmodified plugs and matching outlets will reduce the risk of a lethal electric shock.
2. Avoid body contact with earthed surfaces such as pipes, radiators, kitchen ranges and refrigerators. There is an increased risk of a lethal electric shock if your body is earthed.
3. Do not expose power tools to rain or wet conditions. If water gets inside a power tool, it will increase the risk of a lethal electric shock.
4. Do not damage the electrical cable. Never use the electrical cable for carrying, pulling, or unplugging the power tool. Keep the electrical cable away from heat, oil, sharp edges or moving parts. Damaged or entangled electric cables increase the risk of a lethal electric shock.
5. When operating a power tool outdoors, use an extension cable suitable for outdoor use. Using an extension cable suitable for outdoor use reduces the risk of a lethal electric shock.
6. If operating a power tool in a damp location is unavoidable, use a power supply protected by a residual current device (RCD) with a trip current of not more than 30mA. Using an RCD reduces the risk of a lethal electric shock.
7. Only use extension cables that have been approved for outdoor use and are resistant to splash water. The core diameter for extension cables measuring up to 25 m must be at least 2.5 mm<sup>2</sup>, and 2.5 mm<sup>2</sup> for cables longer than 25m. Always roll the whole cable off the reel before use. Check the cable for damage.

### **PERSONAL SAFETY**

1. This machine is not intended for use by persons (including children) with reduced physical, sensory or mental capabilities, or lack of experience and knowledge, unless they have been given supervision or instruction concerning use of the machine by a person responsible for their safety.
2. Children should be supervised to ensure that they do not use or play with the machine.
3. Stay alert, watch what you are doing and use common sense when operating this machine.
4. Do not use this machine while you are tired, ill or under the influence of drugs, alcohol, or medication. A moment of inattention while operating this machine can cause you to lose control & may result in serious personal injury.
5. Use safety equipment. Always wear eye protection. Safety equipment such as a dust mask, non-skid safety shoes, hard hat, or hearing protection used for appropriate condition will reduce personal injuries.
6. Dress properly. Do not wear loose clothing or jewellery. Keep your hair, clothing & gloves away from moving parts. Loose clothes, jewellery or long hair can be caught in moving parts.
7. Prolonged use of the machine may lead to disorders of blood circulation in hands caused by vibration. These effects can be worsened by low ambient temperatures and/or by gripping the handgrips excessively tightly. Period of use you can extend with appropriate gloves or regular breaks. Take frequent work breaks. Limit the amount of exposure per day.

### **GENERAL MOWING TIPS**

1. When cutting long grass, reduce walking speed to allow for more effective cutting and a proper discharge of the clippings. It is recommended that you cut longer grass in stages. Start at a higher cutting height and go over the same area a second time with a lower cutting height.
2. Do not cut wet grass; it will stick to the underside of the deck and prevent proper collection or discharge of grass clippings.
3. New or thick grass may require a higher cutting height.
4. Empty the grass box regularly, the discharge chute will become blocked with grass cuttings.
5. The mower is designed to operate and cut most effectively when moving forwards.



## INSTRUCTION MANUAL

### KNOW YOUR MACHINE

\* Image may vary from actual machine



1. OPC/Brake Lever	2. Quick Fold Handle
3. Cable Winder	4. Lower Handle
5. Height Adjuster	6. Collector
7. Cable Clip	8. Safety Button
9. Top Handle	10. Cable Tidy

## SET UP & PREPARATION FOR OPERATION

This product must be assembled correctly before use. Carefully remove the product and any accessories from the carton. Inspect the product carefully to make sure there are no breakages or missing items during shipping. Do not discard the packing material and carton until you have carefully inspected and satisfactorily operated the product.



### WARNING

**If any parts are damaged or missing do not operate this product until the parts are replaced. Failure to heed this warning could result in serious personal injury.**

**Do not attempt to modify this product or create accessories not recommended for use with this product. Any such alteration or modification is misuse and could result in a hazardous condition leading to possible serious personal injury.**

**Read and follow all instructions for assembly and operation. Failure to properly assemble this equipment could result in serious injury to the user or bystanders, or cause equipment damage.**

## ASSEMBLY

Open the packaging and remove the device carefully. Remove the packaging material as well as the packaging and transport bracing (if fitted). Check that the delivery is complete. Check the device and accessory parts for transport damage. If possible, store the packaging until the warranty period has expired.

**If you require any assistance with regards to the contents or operation of your machine, please contact us:**

**Tel: 01793 333212, option 2.**

**Email: [customerservice@handydistribution.co.uk](mailto:customerservice@handydistribution.co.uk)**

**Opening Hours Weekdays: (CLOSED WEEKENDS & BANK HOLIDAYS)**

**February to October 8:00am - 5:00pm - November to January 8:30am - 5:00pm**



### WARNING

**The device and packaging materials are not toys!  
Children must not be allowed to play with plastic bags, film and small parts!  
There is a risk of swallowing and suffocation!**

**Stop the motor and unplug the electrical power cable from the power source before any repairs or maintenance operations.**

**DO NOT attempt to start this machine without it first being FULLY assembled.**



## INSTRUCTION MANUAL

### HANDLES

1. The lower handles will arrive inserted into the deck of the machine. Rotate the handle up away from the lawnmower, ensuring the electrical cables are not trapped or crimped.

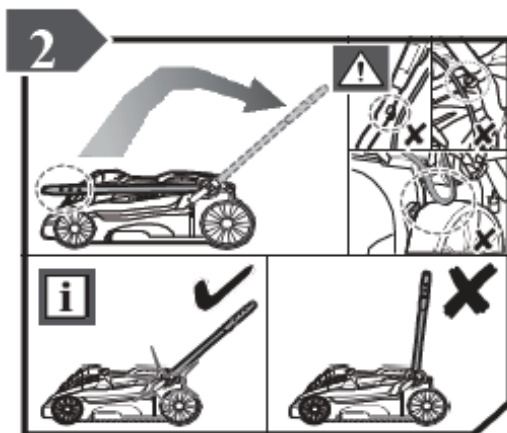

2. Secure the lower handle by folding the quick release handle upwards and repeat on both sides.
3. If the quick release handle is too tight to lift and secure, rotate anti-clockwise to loosen.
4. If the quick release handle is too loose to secure, rotate clockwise to tighten.

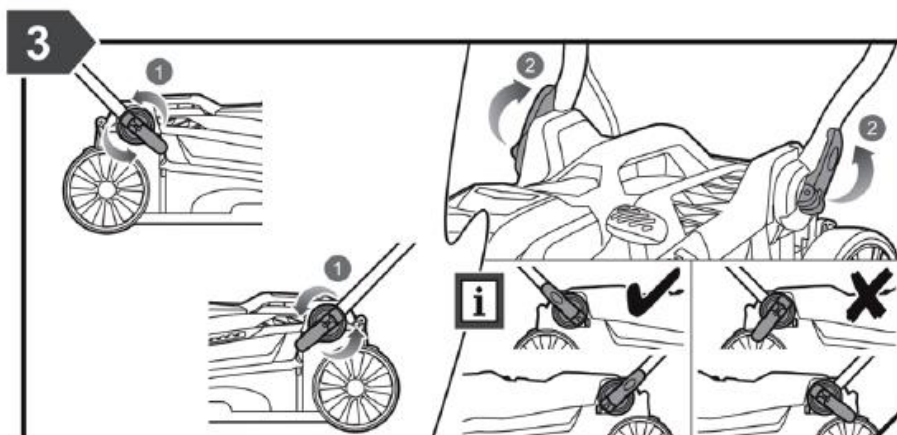

5. Secure the upper handles to the lower handle using the tri-knob, bolt and quick release handle.
6. Select the required height for the user and secure, ensuring the handle assembly is straight and in line with one another.
7. Ensure the electric cables run down the outside of the handle assembly.
8. If the quick release handle is too tight to lift and secure, rotate anti-clockwise to loosen.
9. If the quick release handle is too loose to secure, rotate clockwise to tighten.

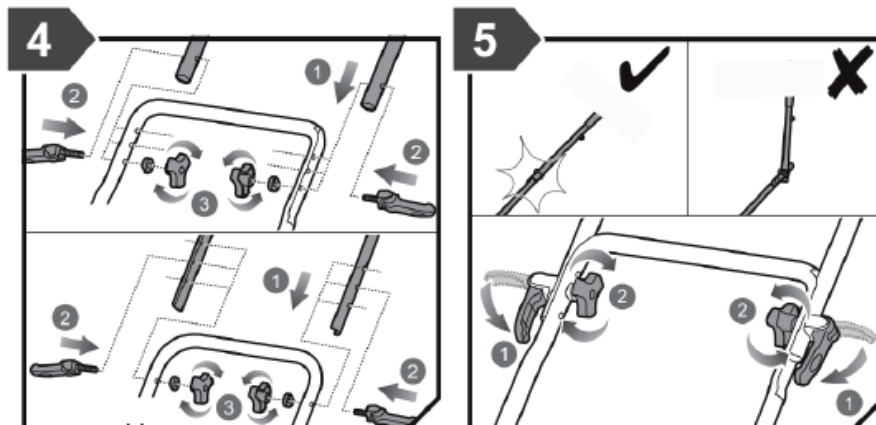

- Secure the electric cable to the handle assembly, using the cable clips provided. They are placed on the right side of the handle assembly, placing the leg of the cable clip into the two pre-drilled holes on the inner side of the handle assembly.

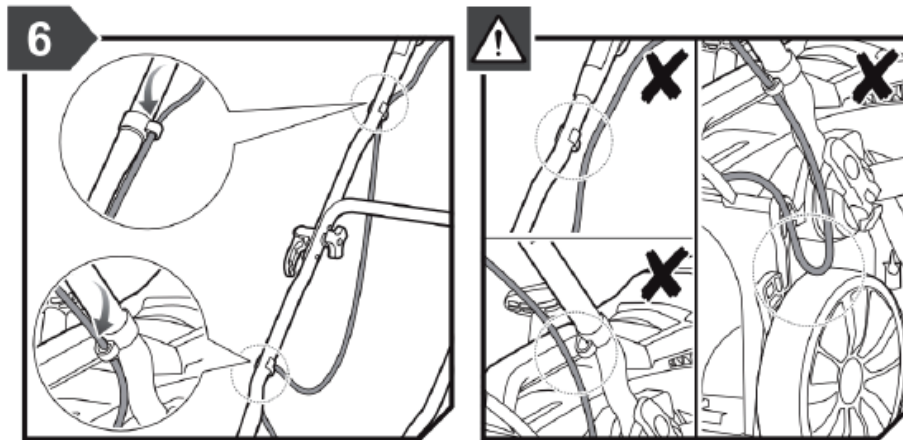

#### FITTING THE COLLECTOR

- Slide the collector handle into the hard top of the collector, placing the tab in first. Then apply downwards pressure to the handle, to ensure the two prongs secure into the hard top of the collector. Position the collector on a hard surface to assist with the handle fitment.
- Ensure the lower mesh of the collector is fully open and away from the collector top.
- Lift the rear grass flap.
- Secure the collector to the machine, ensuring the hooks are firmly housed onto the machine deck

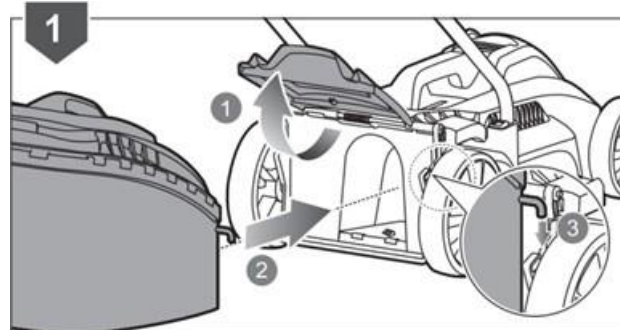



## INSTRUCTION MANUAL

### OPERATION



#### WARNING

Always switch the motor off and remove the electrical plug from the power source before making any adjustments, repairs, or maintenance.

#### ELECTRICAL CABLE

1. Always route the electrical cable away from the work area, to prevent it from meeting the cutting device. Your machine is supplied with a cable tidy, built into the safety button assembly (A). Form a loop in the cable and feed the loop through the cable tidy from the front and hook onto the cable tidy.

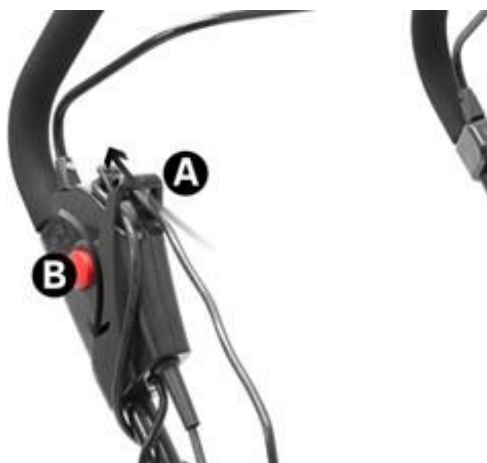

2. Plan your route before starting work. Start your work at the nearest point to the electrical outlet and work away from it.
3. A 13 AMP (BS1363/A) plug must be used, and a 13 AMP fuse must be fitted.

**NOTE: If a molded plug is fitted and must be removed, take great care in disposing of the plug and severed cable, it must be destroyed to prevent engaging into a socket. If the supply cable is damaged, it must be replaced by a service agent or certificated electrician, to ensure the machine can be used safely**

#### POWER CONNECTION



#### WARNING

**Before operating the machine, ensure that the fastening elements are undamaged. To reduce the risk of injuries, always switch off the motor and pull out the mains plug before working on the machine**

The product can be connected to any BS three pin socket with 230-240V alternating current.

We recommend to always use the appliance via a Residual Current Device (RCD) with a tripping current of max. 30mA.

1. Electrical cables are particularly susceptible to insulation damage. The causes of this include the following:
  - Damage through crushing if the cable becomes stuck under doors or windows.
  - Damage through crushing if the cable is trapped during storage.
  - Cracks caused by ageing of the insulation sheath.
2. Kinks caused by incorrect fastening of the cable.
3. Such damaged cables should not be used under any circumstances, as they may cause fatal injuries due to a damaged insulation sheath.
4. Always check the plug and cable and make sure they are in good condition before operation.

## STARTING THE MOTOR



### WARNING

The cutting blade begins to rotate as soon as the motor is started.  
A rotating cutting unit can cause injuries.

1. Connect the lawnmower to the power supply. Ensure it meets the recommended requirements above.
2. Ensure the lawnmower is within the grassed area to be worked.
3. Press the safety button (A) and whilst depressed, pull the OPC/Brake lever up to the upper handle.
4. The lawnmower will start, and the blade immediately rotates.
5. Whilst continuing to hold the OPC/Brake lever up to the top handle, you can now release the safety button and begin to mow.



## STOPPING THE MOTOR

1. To stop the motor, release the OPC/Brake Lever.
2. Disconnect the electrical plug from the mains.

### **IMPORTANT:**

*The blade continues to rotate for a few seconds after the motor is switched off. Never attempt to stop the blade yourself. If the blade strikes an object, immediately switch off the machine and wait for the blade to come to a complete stop. Inspect the condition of the blades. Replace any parts that are damaged.*





## INSTRUCTION MANUAL

### ADJUSTING CUTTING HEIGHT

1. The single height adjustment lever is located on the left side of the lawnmower.
2. Push the lever away towards the wheel and lift up or down the five settings, depending on your needs.
3. The gauge has five cutting heights, numbered 1-5, with 1 being the lowest cut (20mm) and 5 the highest cut 70cm. Adjust the cutting height to suit your requirements. The 3 position is best for most lawns.

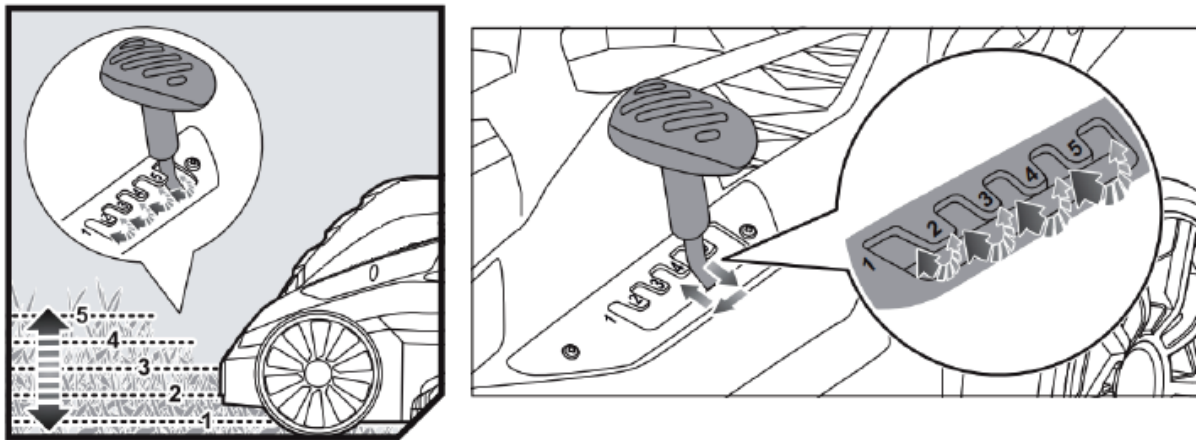

### COLLECTOR FULL INDICATOR

Your machine grassbox collector is fitted with a full indicator flap at the rear of the hard top. Whilst air is still rotating around the collector and grass is being collected, the flap will raise and remain open. Once the collector is full, the flap will remain closed and you should empty the grassbox.

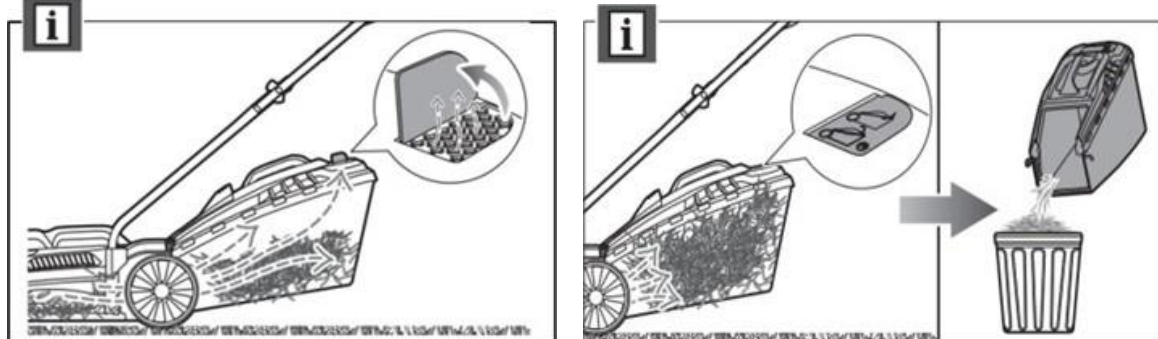

### EMPTYING COLLECTOR

When the collector is ready for emptying.

1. Release the OPC/Brake lever and wait for the cutting blade to come to a complete stop.
2. Lift the rear grass flap.
3. Unhook the collector.
4. Empty the collector contents into a suitable waste recycling bin or compost heap.
5. Refit the empty collector.

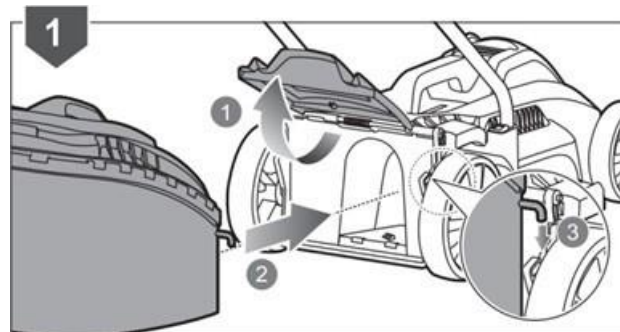



## MOWING TIPS



### WARNING

The operation of any lawnmower can result in foreign objects being thrown into eyes, which can cause severe damage. Always wear safety glasses or goggles while operating the lawnmower, or while performing any adjustments or repairs on it.

Shut the motor off and wait until the lawnmower comes to a complete stop before cleaning the cutting deck and discharge areas. The cutting blade continues to rotate for a few seconds after the machine is turned off.

Under certain conditions, such as very tall grass, it may be necessary to raise the height of cut to reduce pushing effort, prevent overloading of the motor and leaving clumps of grass clippings. It may also be necessary to reduce ground speed and/or push the lawn mower over the area a second time. For extremely heavy cutting, reduce the width of cut by overlapping the previously cut path and mow slowly. The side combs allow the machine to cut up to walls.

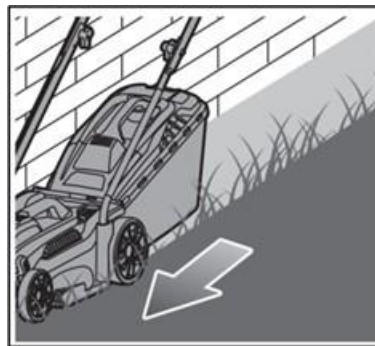
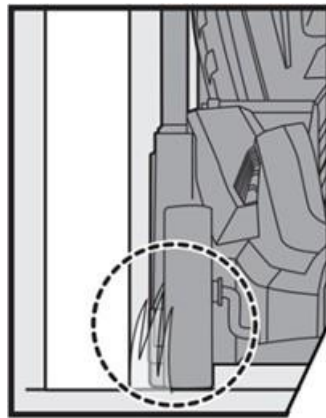

## CUTTING ON SLOPES

When cutting on slopes, ensure your footing is secure, the grass is not wet and the machine is used across the slope and not up or down the slope. The slope gradient should not exceed 15°.

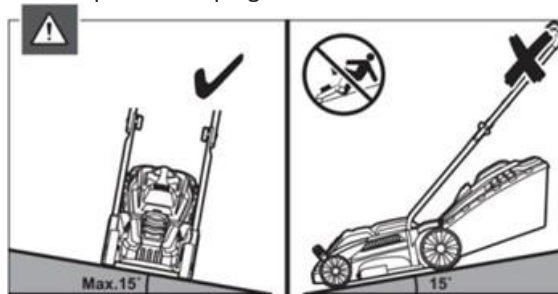

## TRANSPORT

When moving the machine to and from the work area, always ensure the electrical plug is removed from the power source.



## INSTRUCTION MANUAL

### ELECTRICAL CONNECTION

The electrical motor installed is connected and ready for operation. The connection complies with the applicable VDE and DIN provisions. The customer's mains connection as well as the extension cable used must also comply with these regulations.

#### Damaged electrical connection cable

The insulation on electrical connection cables is often damaged.

This may have the following causes:

- Passage points, where connection cables are passed through windows or doors.
- Kinks where the connection cable has been improperly fastened or routed.
- Places where the connection cables have been cut due to being driven over.
- Insulation damage due to being ripped out of the wall outlet.
- Cracks due to the insulation ageing.

Damaged electrical connection cables must not be used and are life-threatening due to the insulation damage. Check the electrical connection cables for damage regularly. Make sure that the connection cable does not hang on the power network during the inspection.

Electrical connection cables must comply with the applicable VDE and DIN provisions. Only use connection cables with the marking „H05VV-F“.

The printing of the type designation on the connection cable is mandatory.

#### AC motor

The mains voltage must be 230 V~

Extension cables up to 25m long must have a cross-section of 2.5 mm<sup>2</sup>.

Connections and repairs of electrical equipment may only be carried out by an electrician.

Please provide the following information in the event of any enquiries:

- Type of current for the motor
- Machine data - type plate
- The product meets the requirements of EN 61000-3-11 and is subject to special connection conditions. This means that use of the product at any freely selectable connection point is not allowed.
- Given unfavourable conditions in the power supply the product can cause the voltage to fluctuate temporarily.
- The product is intended solely for use at connection points that
  - a. do not exceed a maximum permitted supply impedance "Z", or
  - b. have a continuous current-carrying capacity of the mains of at least 100 A per phase.
- As the user, you are required to ensure, in consultation with your electric power company if necessary, that the connection point at which you wish to operate the product meets one of the two requirements, a) or b), named above.

## MAINTENANCE, CLEANING & STORAGE



### WARNING

**Improper maintenance & storage of the machine may void your warranty. Keep the machine clean for better and safer performance.**

**Turn off the motor and remove the electrical plug from the power source before performing any maintenance. Never tilt, lift, or carry the machine while the motor is running.**

### MAINTENANCE

#### General Recommendations

1. Always observe safety rules when performing any maintenance.
2. The warranty on this machine does not cover items that have been subjected to operator abuse or negligence. The operator must maintain the machine as instructed.
3. Changing of the motor speed will void warranty.
4. All adjustments should be checked at least once each season.
5. Keep all nuts, bolts and screws tight to be sure the equipment is in safe working condition. Regular maintenance is essential for safety and performance.
6. Do not use the equipment with worn or damaged parts, this can be dangerous. Parts are to be replaced and not repaired. Use genuine spare parts. Parts that are not of the same quality can damage the equipment and create safety hazards.
7. Wear strong work gloves when removing and reassembling the blade.
8. Check the blade's balance after sharpening.
9. Check the grass flap and grassbox collector frequently for wear and deterioration.
10. Whenever the machine is to be handled, transported or tilted you must:
  - ✓ Wear strong working gloves;
  - ✓ Grasp the machine at the points that offer a safe grip, taking account of the blades, the mower's weight and its distribution.

### BLADE MAINTENANCE



**The cutting blade will continue to rotate after the motor is switched off. Slicing is possible if care is not taken. Wear appropriate hand coverage.**

1. Remove the electric plug from the mains supply.
2. Clean the underside of the deck with a stiff brush, before any maintenance is undertaken to the blade.

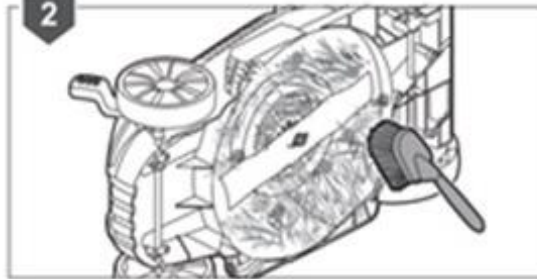



## INSTRUCTION MANUAL

### REMOVE OR REPLACE THE BLADE

1. Block the rotation of the blade, using a good-sized piece of wood, which the blade cannot cut.
2. Hold the blade using gardening gloves (not provided) and spanner (not provided) rotating the spanner anti-clockwise.
3. Remove the bolt, washer and blade. Dispose of the old blade responsibly if replacing.
4. Attach a new blade, fastening with the washer and blade bolt. Ensure that the blade is correctly positioned on the blade boss and then firmly tighten the bolt, clockwise.

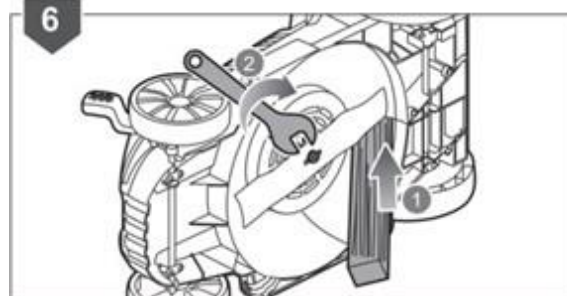
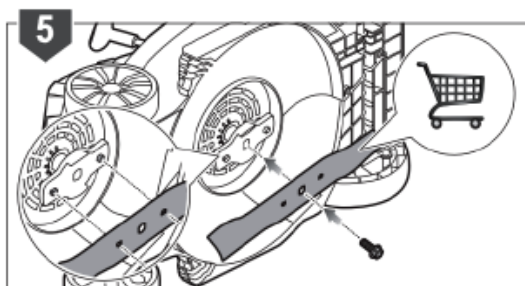
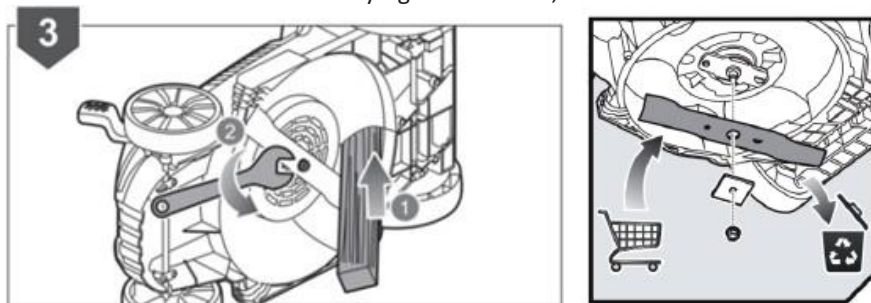

### CLEANING

Always remove the electric plug from the mains supply before any cleaning is undertaken.



Carefully clean the underside of the deck with a stiff brush after each cut; remove the grass debris and mud accumulated inside the deck to prevent it drying. Do not use water on any part of the main machine!

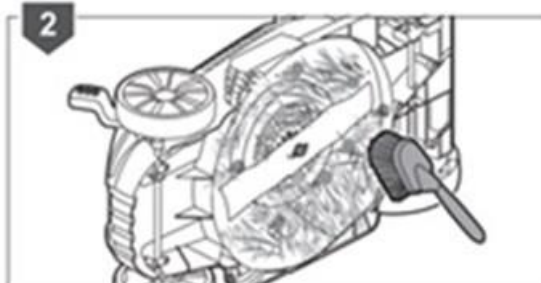

### COLLECTOR CLEANING

Pores in the grassbox can become filled with dirt and dust, during use and will collect less grass. To prevent this, regularly hose the catcher off with water and let dry before using. Keep the top of the motor housing vents clear and clean of grass clippings & dust. This will assist motor air flow and extend the machine life.

## MOTOR CARE



### WARNING

**Do not use a water hose or pressure washer to clean the machine. Water can damage the motor.  
Do not use hard or pointed objects for cleaning the machine.**

- Always keep the lawnmower, wheels axles and air vents clean. Use a brush or cloth to clean it, avoid cleaners and solvents.
- Always check that the lawnmower and especially the guards are not worn down or damaged but firmly attached before use. Check that the nuts, bolts and screws are tight.
- Check the covers and guards for damage and improper attachment. If necessary, change the components

## STORAGE & TRANSPORT

The following steps should be taken to prepare your machine for storage.



### CAUTION

**The motor must have completely cooled down before storing.**

**NOTE:** When storing any type of power equipment in an unventilated or material storage shed,

- For trouble free service, make sure the machine is clean and dry before storing.
- Keep the lawnmower in a dry place out of children's reach. Do not cover the lawnmower, moisture may develop.
- Store indoors or in a safe dust free area, locked protected area during severe weather and winter months. If storing for an extended period, inspect, clean and repair the machine if necessary. Please ensure the machine is stored away from direct sunlight.
- Be careful not to bend or kink cables.
- Ensure the machine is stored in a position, where any persons cannot step on to attempt to reach items up high, due to risk of movement.

For compact storage follow these steps.

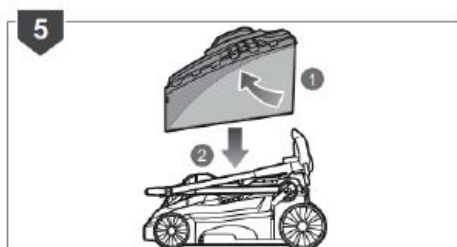
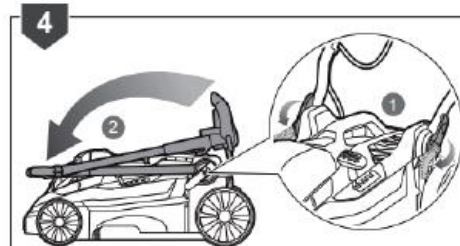
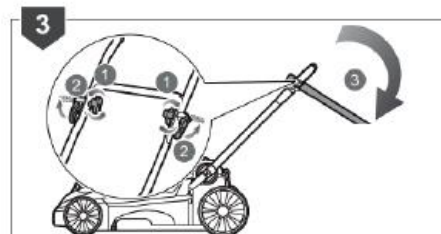
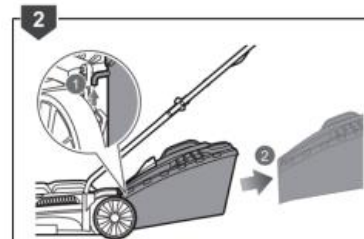

### MAINTENANCE INFORMATION

Please note that the following parts of this product are subject to normal or natural wear and that the following parts are therefore also required for use as consumables.

Wear & Tear parts\*: Carbon brushes, cutting blade, collector (\* Not necessarily included in the scope of delivery!)

### DISPOSAL & RECYCLING

The equipment is supplied in packaging to prevent it from being damaged in transit. The raw materials in this packaging can be reused or recycled. The equipment and its accessories are made of various types of material, such as metal and plastic. Defective components must be disposed of as special waste. Ask your dealer or your local council.

### TROUBLE SHOOTING

PROBLEM	REMEDIAL ACTION
Motor does not start	Check the mains connection cable, plug fuse and circuit breaker.
	Start on short grass or on an area which has already been mown.
	Unplug the mower. Clean the discharge chute/housing, the blade must rotate freely.
	Correct the cutting height.
Reduced Motor Power	Correct the cutting height.
	Clean the discharge chute/housing.
	Have the blade re-sharpened or replaced by an authorised service dealer.
The grass collector does not fill completely	Correct the cutting height.
	Allow the lawn to dry.
	Have the blade re-sharpened or replaced by an authorised service dealer.
	Clean the grille on the grass catcher.
	Clean the discharge chute/housing.





# INSTRUCTION MANUAL

## PARTS DIAGRAM - WEER36 1938123002

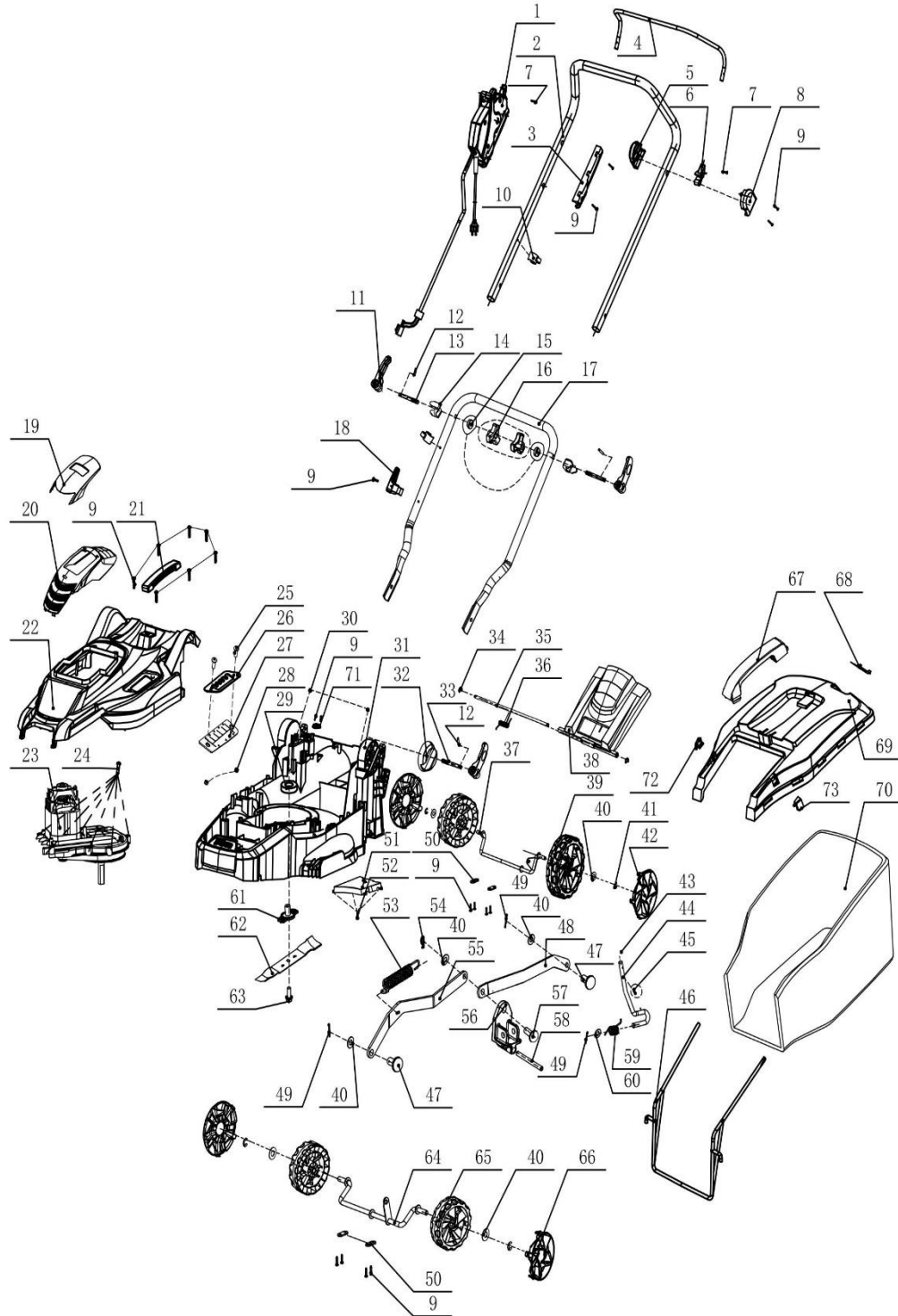

**NOTE:** Parts Lists are supplied for information purposes only, not all parts are stocked individually & we recommend you contact our Spares Team on 01793 333212 for expert advice.



## PARTS LIST - WEER36 1938123002

Item No.	Webb Part No.	Webb Description	Qty	Item No.	Webb Part No.	Webb Description	Qty
1	WE125-4080063	Switch Box Assembly	1	37	WE125-103050259	Rear Axle	1
2	WE125-103080444	Top Handle (With Foam)	1	38	WE124-301070916	Grass Flap	1
3	WE125-0301062831	Switch Box Small Cap	1	39	WE125-301070924	Rear Wheel	2
4	WE125-103990876	OPC Lever	1	40	WE125-104010258	Washer	7
5	WE125-301070717	Left Permanent Seat	1	41	WE125-104050024	Split Washer	4
6	WE125-301062827	Left Clamp	1	42	WE125-301070923	Rear Wheel Trim	2
7	WE125-104040082	M4x8 Bolt	3	43	WE125-301062852	Height Adjuster Handle	1
8	WE125-301070716	Left Fix Cover	1	44	WE125-103990880	Height Adjuster Lever	1
9	WE125-104030136	ST4.2X15BT Screw	23	45	WE125-104030203	M4x8 Screw	2
10	WE125-0301070806	Cable Clip	2	46	WE125-103020147	Collector Support	1
11	WE125-301070899	Quick Release Handle	4	47	WE125-301062851	Pin Shaft (LMA36)	2
12	WE125-103990795	Spring Pin	4	48	WE125-103990799	Back Connecting Rod	1
13	WE125-104040202	M8x73 bolt	2	49	WE125-103990811	Split Pin	3
14	WE125-301070779	Quick Release Support	2	50	WE124-103990797	Press Plate	6
15	WE125-301070780	Quick Release Washer	2	51	WE125-301070837	Axle Cover	1
16	WE125-301070781	Triangle Knob	2	52	WE125-104030135	ST4.2*12 Screw	4
		Hex Nut	2	53	WE125-103060289-1	Tension Spring	1
17	WE125-103020159	Lower Handle	1	54	WE125-103990750	Pin	1
18	WE124-16	Cable Winder	2	55	WE125-103990798	Front Connecting Rod	1
19	WE124-301070910	Motor Cover	1	56	WE125-301062854	Adjusting Bracket	1
20	WE124-301070911	Air Window Cover	1	57	WE125-301062853	Long Pin Shaft (LMA36)	1
21	WE124-301070396F	Motor Cover Carry Handle	1	58	WE125-103050261	Adjusting Bracket Shaft	1
22	WE125-301070920	Upper Cover	1	59	WE125-103060285	Torsional Spring	1
23	WE125-04070249	Motor Assembly	1	60	WE125-104010257	Washer	7
24	WE125-104030423	ST4.2x18 Screw	7	61	WE125-301070794	Blade Support Plate	1
25	WE125-104030300	M5x12 Screw	2	62	WE125-103030127	Blade	1
26	WE125-103990881	Height Adjuster Back Plate	1	63	WE124-104040205	Blade Flange Bolt	1
27	WE125-105020068	Gland	1	64	WE125-103050274	Front Axle	1
28	WE125-104020017	Locknut	2	65	WE125-301062850	Front Wheel	2
29	WE124-103050242	Shield Bearing	1	66	WE125-301062849	Front Wheel Trim	2
30	WE125-104020077	Hex Nut	2	67	WE124-301070580P	Collector Carry Handle	1
31	WE125-301070921	Upper Deck	1	68	WE124-301062859	Full Indicator Flap	1
32	WE125-301070902	Lower Handle Adjuster	2	69	WE124-301070917	Collector Top	1
33	WE125-104040215	Adjusting Bolt	2	70	WE125-105011067	Lower Collector	1
34	WE124-104050028	Split Washer	2	71	WE125-301990135	Pressing Line Plate	1
35	WE124-103050260	Grass Flap Axle	1	72	WE125-301070919	Collector Right Plug	1
36	WE124-103060300	Torsional Spring	1	73	WE125-301070922	Collector Left Plug	1

**NOTE:** Parts Lists are supplied for information purposes only, not all parts are stocked individually & we recommend you contact our Spares Team on 01793 333212 for expert advice.



# INSTRUCTION MANUAL

## PARTS DIAGRAM - WEER40 1938124003

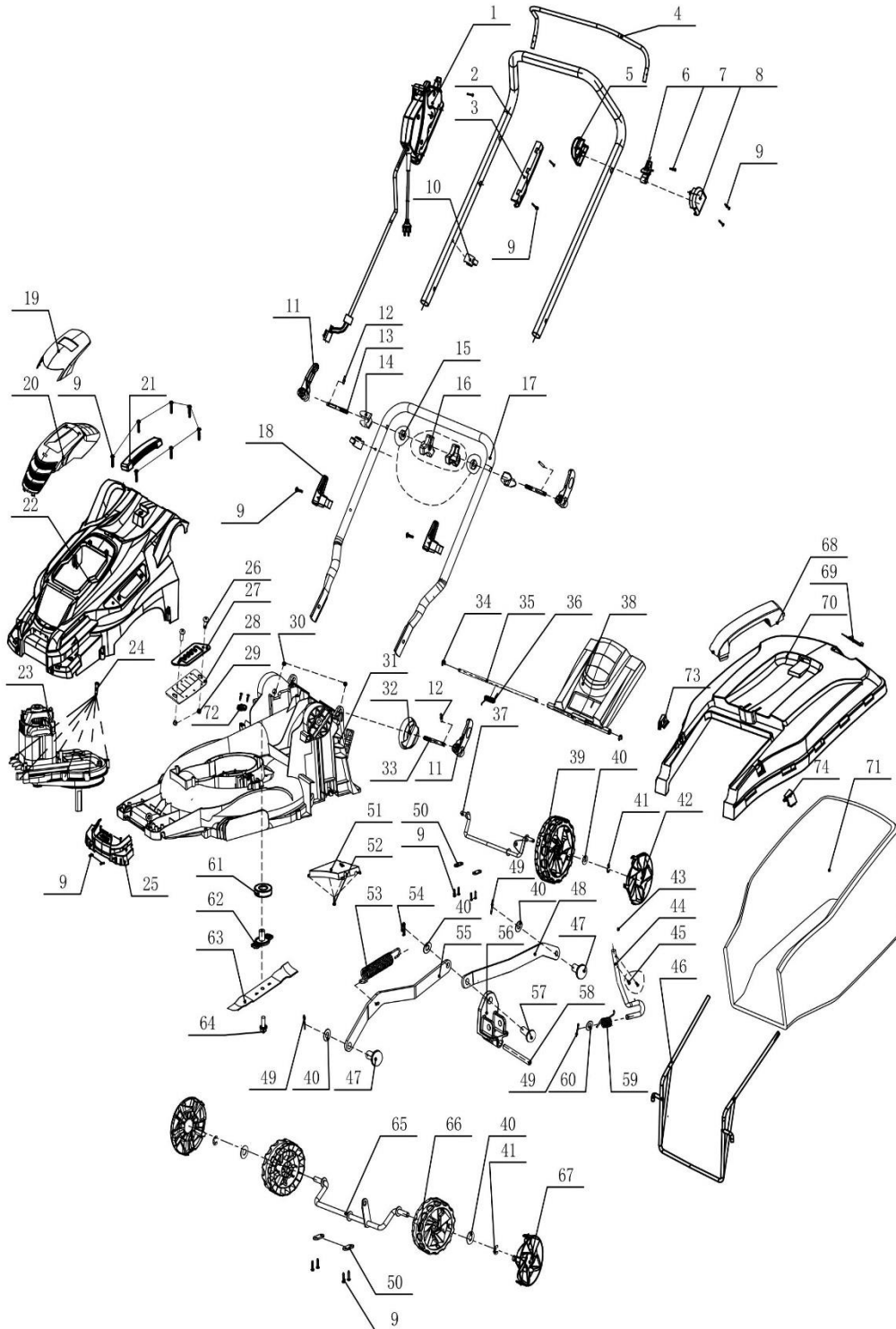

**NOTE:** Parts Lists are supplied for information purposes only, not all parts are stocked individually & we recommend you contact our Spares Team on 01793 333212 for expert advice.

## PARTS LIST - WEER40 1938124003

Item No.	Webb Part No.	Webb Description	Qty	Item No.	Webb Part No.	Webb Description	Qty
1	WE126-4080061	Switch Box Assembly	1	38	WE126-301070903	Grass Flap	1
2	WE125-103080444	Top Handle (With Foam)	1	39	WE126-301062836	Rear Wheel	2
3	WE125-0301062831	Switch Box Small Cap	1	40	WE125-104010258	Washer	7
4	WE125-103990876	Opc Lever	1	41	WE125-1040500024	Split Washer	4
5	WE125-301070717	Left Permanent Seat	1	42	WE126-301062835	Rear Wheel Trim	2
6	WE125-301062827	Left Clamp	1	43	WE125-301062852	Height Adjuster Handle	1
7	WE125-104040082	M4x8 Bolt	3	44	WE126-103990877	Height Adjuster Lever	1
8	WE125-301070716	Left Fix Cover	1	45	WE125-104030203	M4x8 Screw	2
9	WE125-104030136	ST4.2X15BT Screw	23	46	WE126-103020148	Collection Bag Frame	1
10	WE125-0301070806	Cable Clip	2	47	WE125-301062851	Pin Shaft	2
11	WE125-301070899	Quick Release Handle	4	48	WE125-103990799	Back Connecting Rod	1
12	WE125-103990795	Spring Pin	4	49	WE125-103990811	Split Pin	3
13	WE125-104040202	M8x73 Bolt	2	50	WE124-103990797	Press Plate	6
14	WE125-301070779	Quick Release Support	2	51	WE126-301070797	Housing Insert	1
15	WE125-301070780	Quick Release Washer	2	52	WE125-104030135	St4.2*12 Screw	4
16	WE125-301070781	Triangle Knob	2	53	WE125-103060289-1	Tension Spring	1
		Hex Nut	2	54	WE125-103990750	Pin	1
17	WE126-103020160	Lower Handle	1	55	WE125-103990798	Front Connecting Rod	1
18	WE124-16	Cable Winder	2	56	WE126-301070796	Adjusting Bracket	1
19	WE124-301070910	Motor Cover	1	57	WE125-301062853	Long Pin Shaft	1
20	WE124-301070911	Air Window Cover	1	58	WE126-103050254	Adjusting Bracket Shaft	1
21	WE124-301070396F	Motor Cover Carry Handle	1	59	WE125-103060285	Height Adjuster Spring	1
22	WE126-301070900	Upper Deck	1	60	WE125-104010257	Washer	7
23	WE126-04070214	Motor Assembly	1	61	WE124-103050242	Bearing	1
24	WE125-104030423	ST4.2x18 Screw	7	62	WE125-301070794	Blade Support Plate	1
25	WE126-301070901	Front Bumper	1	63	WE126-103030128	Blade	1
26	WE125-104030300	M5x12 Screw	2	64	WE124-104040205	M8x20 Blade Flange Bolt	1
27	WE126-103990796	Height Adjuster Back Plate	1	65	WE126-103050273	Front Axle	1
28	WE126-105020065	Height Adjuster Frame	1	66	WE125-301062850	Front Wheel	2
29	WE125-104020017	Locknut	2	67	WE125-301062849	Front Wheel Trim	2
30	WE125-104020077	Hex Nut	2	68	WE124-301070580P	Collector Carry Handle	1
31	WE126-301070789	Lower Deck	1	69	WE124-301062859	Full Indicator Flap	1
32	WE125-301070902	Lower Handle Adjuster	2	70	WE126-301070904	Collector Top	1
33	WE125-104040215	Adjusting Bolt	2	71	WE126-105011065	Lower Collector	1
34	WE126-104050022	Split Washer	2	72	WE125-301990135	Pressing Line Plate	1
35	WE126-103050256	Grass Flap Axle	1	73	WE126-301070905	Grass Collecting Basket Right Plug	1
36	WE126-103060290	Grass Flap Spring	1	74	WE126-301070906	Grass Collecting Basket Left Plug	1
37	WE126-10305272	Rear Axle	1				

**NOTE:** Parts Lists are supplied for information purposes only, not all parts are stocked individually & we recommend you contact our Spares Team on 01793 333212 for expert advice.



## EC DECLARATION OF CONFORMITY

We Handy Distribution Ltd - SN3 5HY (Importer) declare that the product:

**Designation:** Electric 1600W 36cm Rotary Lawnmower

**Model(s):** WEER36

**Product No.:** 1938123002

**Type/Serial No.** As per rating label on machine

**Complies with the following directives:**

**Machinery Directive 2006/42/EC**

**The conformity assessment procedure followed was in accordance with:**

EN 60335-1; EN 62233; EN55014-1; EN55014-2; EN 61000-3-2; EN13683

**Electromagnetic Capability Directive 2014/30/EU**

**The conformity assessment procedure followed was in accordance with:**

EN55014-1 :2006/+A1 :2009/+A2/2011, EN55014-2 :2015, EN61000-3-2 :2014, EN61000-3-11 :2000

**Noise Directive 2000/14/EC**

**Examination of the above appliances using the requirements and test methods of**

ISO 11094 :1991, EN ISO 3744 :1995 & Annex III of 2000/14/EC amended by 2005/88/EC

**Declared Guaranteed Sound Power Level  $L_{WA}$ :** 96 dB(A)

**Test Notified Body:**

Intertek Testing Services Shanghai

**Authorised signatory and technical file holder**

**Date:** 25/01/2022

**Signature:**

A handwritten signature in black ink, appearing to read "S Belcher", written over a horizontal line.

**Name:** Mr Simon Belcher

**Position:** Chairman

**Company:** Handy Distribution Ltd

**Address:** Murdock Rd, Swindon, Wiltshire, SN3 5HY.





## EC DECLARATION OF CONFORMITY

We Handy Distribution Ltd - SN3 5HY (Importer) declare that the product:

**Designation:** Electric 1600W 36cm Rotary Lawnmower

**Model(s):** WEER40

**Product No.:** 1938124003

**Type/Serial No.** As per rating label on machine

**Complies with the following directives:**

**Machinery Directive 2006/42/EC**

**The conformity assessment procedure followed was in accordance with:**

EN 60335-1; EN 62233; EN55014-1; EN55014-2; EN 61000-3-2; EN13683

**Electromagnetic Capability Directive 2014/30/EU**

**The conformity assessment procedure followed was in accordance with:**

EN55014-1 :2006/+A1 :2009/+A2/2011, EN55014-2 :2015, EN61000-3-2 :2014, EN61000-3-11 :2000

**Noise Directive 2000/14/EC**

**Examination of the above appliances using the requirements and test methods of**

ISO 11094 :1991, EN ISO 3744 :1995 & Annex III of 2000/14/EC amended by 2005/88/EC

**Declared Guaranteed Sound Power Level  $L_{WA}$ :** 96 dB(A)

**Test Notified Body:**

Intertek Testing Services Shanghai

**Authorised signatory and technical file holder**

**Date:** 25/01/2022

**Signature:**

A handwritten signature in black ink, appearing to read "S Belcher", written over a horizontal line.

**Name:** Mr Simon Belcher

**Position:** Chairman

**Company:** Handy Distribution Ltd

**Address:** Murdock Rd, Swindon, Wiltshire, SN3 5HY.





## INSTRUCTION MANUAL

This Service Book is provided with your Webb, to help you look after your purchase to our recommendations and enable you to take advantage of the conditional manufacturer domestic warranty\*.

Present this service book to your authorised Webb repair dealer, whenever a service or a warranty appraisal is required.

The booklet is applicable to the following products, in the UK only:

- Ride On Lawn Tractors
- Cylinder Lawnmowers
- Petrol Rotary Lawnmowers
- Petrol Hand Held Range

Please register your machine using the following pages or at [www.webbgardenpower.co.uk](http://www.webbgardenpower.co.uk). By registering your machine, you agree to maintain the machine in accordance with the service schedules specified in this manual and services duly recorded. (Not applicable for Webb electric handheld machines). You may be asked to produce this booklet as proof of servicing in the event of a claim. Proof of purchase should also be kept as a reference.

Ensure you have the following information available from your machine product label. The two examples below can be found on your machine:



1. Model Number

2. Serial & Product Number

Please complete using BLOCK CAPITALS.  
Sections marked\* must be completed to validate Warranty.

# SERVICE BOOK

## 1. Users Statement of Warranty

Each new machine is warranted against defective material or assembly of material under normal usage. The warranty applies to the original purchaser, is not transferable and covers faulty parts and the labour involved in replacing and repairing those parts, which are of original manufacture.

## 2. Period of Warranty - valid from 1 January 2020

**Webb (excludes Dynamic, Legacy & Heritage)**, 2 year conditional warranty from the original date of sale to the first domestic user.

**Webb (Dynamic, Legacy & Heritage)** 1 year warranty from the original date of sale to the first domestic user.

90 days from the original date of sale to the professional/commercial or for hire user.

Engine warranty as per the engine manufacturer's warranty, which will be supplied with the machine.

90 days from the original date of sale for Replacement Spare Parts

All machines' must be serviced within the first 14 months from the original date of purchase, to qualify for a second year parts & labour warranty, details of the service must be recorded in the service record within this manual.

A reduced warranty period of 90 days applies to those items which are subject to normal wear and tear and in normal use, will need replacement or adjustment.

These items are chargeable after 90 days of ownership.

Filters  
Tyres / Wheels  
Drive chains and belts  
Brake & clutch friction components  
Control cable & starter cords  
Fluids & lubricants  
Spark plugs  
Blades (Lawnmowers & Brushcutters)  
Cutter bars (Hedgecutters)  
Drive & clutch cable surfaces  
Nylon Lines (Line Trimmers)  
Carburettor cleaning  
Bearings  
Bushes  
Electric cable  
Grass collectors

## 3. Not covered by this warranty

(a) The warranty policy does not cover any depreciation or damages caused by ordinary wear, rusting or corrosion, lack of correct maintenance or operation, misuse, abuse, lack of transportation or accident.

(b) The warranty policy does not cover any costs necessary for the standard periodic maintenance services instructed by the operators manual, or service parts replacement which would include oil, filters, tyres, belts, brake linings, fuses, blades, seals and other service parts unless it can be proven that the item has evidence of faulty manufacture.

(c) The warranty policy will not cover failure or damage caused as a result of parts or accessories being modified without the written approval of GJ Handy & Co Ltd.

(d) The warranty policy will not cover the unit if non-genuine parts have been fitted and as a result damage has occurred to the unit.

(e) The warranty policy is non-transferable and is only applicable to the original purchaser.

## 4. Disclaimer

(a) This warranty is only a remedy for defect of products. GJ Handy & Co Ltd will never warranty in terms of the merchantability or the fitness for a particular purpose.

(b) No person is authorised to make any warranties, representations or promises, expressed or implied, on behalf of GJ Handy & Co Ltd, or to modify the terms conditions or limitation of this warranty policy in any way.





## INSTRUCTION MANUAL

(c) Neither GJ Handy & Co Ltd nor any company affiliated with GJ Handy & Co Ltd shall be liable in any event or manner whatsoever for incidental or consequential damages or injuries, including, but not limited to, loss of crops, loss of profit, out of pocket expenses or profits, rental of substitute equipment or other commercial losses.

### *5. General*

(a) Most warrantable failures show up within the first few weeks of use. These failures are usually straightforward and warranty assessment is relatively easy.

(b) Failures relating to cutter decks and belts need careful investigation, as the cause may not always be straightforward. Look for damage to blades and pulleys especially when the cutter belt or blade boss have snapped or cracked as this could be due to impact damage.

(c) Customers should always refer to the operator/instruction manual when any disputed problem arises, you will find most areas covered within the manual.

## Protecting your machine

### *Maintenance*

Regular maintenance of your Webb machine is essential to ensure it operates, safely, efficiently and therefore reducing the environmental impact.

It is the owner's responsibility to ensure that their Webb machine is maintained at specific intervals. Any approved Webb service dealer can undertake a service, which are specialised in our products and will be aware of your particular machine and any technical updates which will save valuable time & money.

If you are using your machine in dry, dusty or high temperatures, you will need to service the machine more regularly.

### *Fuel (if applicable)*

Due to ongoing efforts by fuel companies to reduce emissions, unleaded petrol will oxidize & deteriorate in storage overtime, leaving residue from detergent components.

Fuel deterioration problems may occur when petrol is stored for over 30 days. If you are planning to store fuel for over 30 days, we recommend you add Handy Parts Sure-Start fuel stabilizer to fresh fuel after purchasing. Sure-Start cannot reconstitute stale fuel.

### *Storage*

When storing your machine for an extended period, we do recommend that you follow the instructions of engine instruction manual.

Always store the fuel in a clean, approved and sealed container. If the container is steel, ensure it is not corroded. If the container is not filled to its recommended capacity, air can accelerate fuel deterioration.

Always store fuel away from direct sunlight, in a dark, cool environment.



# SERVICE BOOK

Your servicing Webb approved dealer will stamp & date the below relevant sections, when the correct service actions have been completed.  
PLEASE ENSURE THE SERVICE BOOK IS AVAILABLE FOR THE DEALER, DURING SERVICE WORK.

## 1st Service

This must be stamped by an approved service dealer to qualify for a free second year warranty.  
(Excluding the Webb Electric Handheld machines)

12 Months

Date

24 Months

Date

36 Months

Date



## INSTRUCTION MANUAL

48 Months

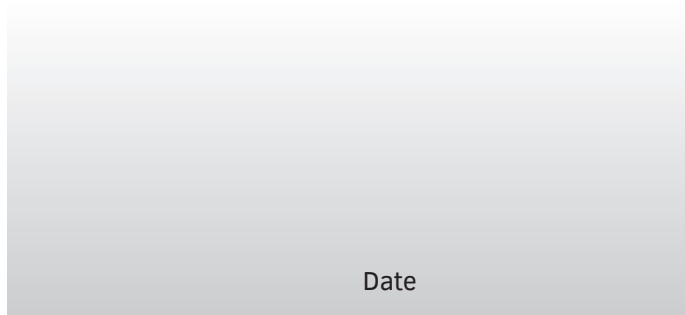

60 Months

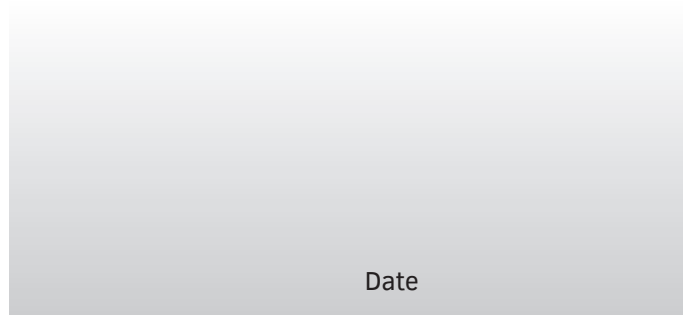

72 Months

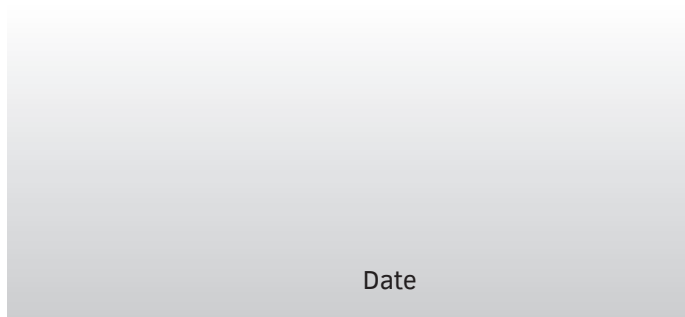

84 Months

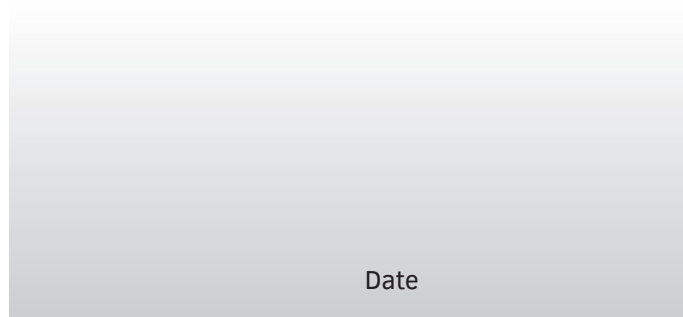

96 Months

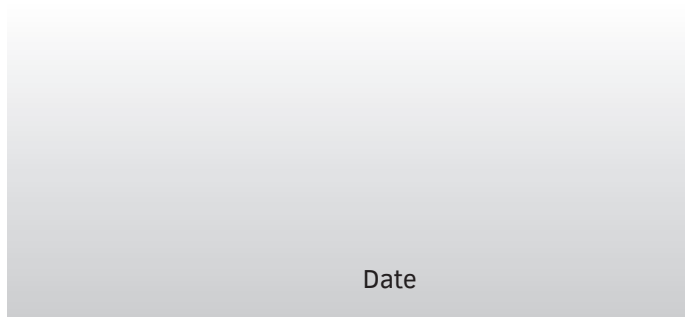

108 Months

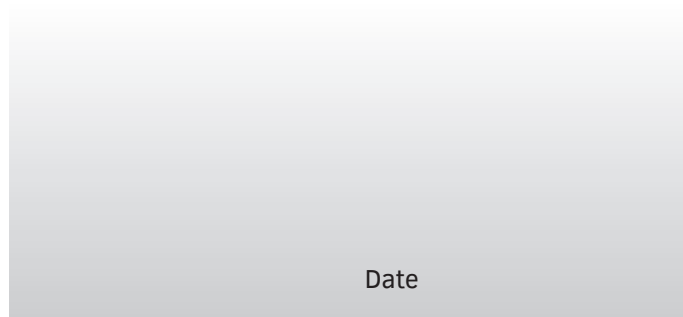

120 Months

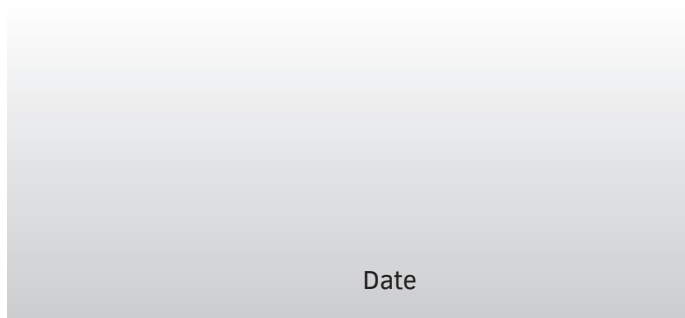

132 Months

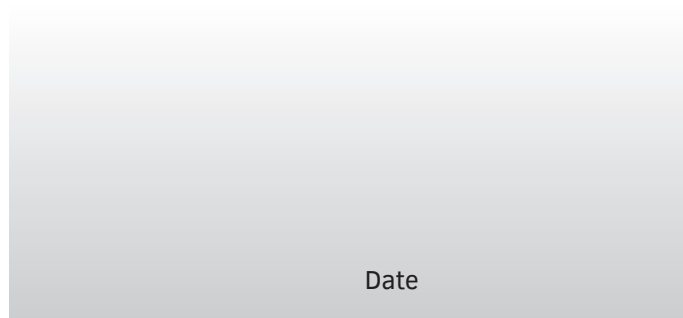

If you have registered online, this form is not necessary.  
PLEASE POST THIS COPY TO THE ADDRESS OVERLEAF

Product Information (\* Compulsory)

*Model No:	
*Product No:	
*Serial No:	
*Date of Purchase:	

Personal Information (\* Compulsory)

*Title		*Forename		*Surname		
*House Number		*House Name				
*Address 1						
*Address 2						
*Town						
*County						
*Postcode						
Home Tel				Mobile Tel		
Email						

Age	18 to 25		26 to 35		36 to 45		46 to 60		61 to 80		81 & over	
*Usage	Domestic Use				Commercial/Professional/Hire Use							

\*Dealer Stamp (if available)

--

\*Selling Retailer (If dealer stamp not available)

*Dealer Name	
*Dealer Address	
*Date of Purchase	

Webb Lawnmowers privacy commitment to machine owners.

The information supplied, helps us to improve the products & services we provide, including information that we believe is relevant to your and/or your machine. We value your trust by giving us this information about yourself and we are committed to protecting your privacy.

Webb, its associated companies, authorised dealers or third parties working on our behalf may wish to contact you regarding **PRODUCT RECALLS** specific to your machine. Please advise how you wish to be contacted for this specific reason only:

Post  Telephone  Email

From time to time Webb, its associated companies, authorised dealers or third parties working on our behalf may wish to contact you regarding our products, services, offers or just opinions, which may be used for marketing, research or analysis purposes.

If you wish to be contacted by any of the following methods, please tick the relevant boxes:

Post  Telephone  Email

You may give Webb Lawnmowers notice in writing at any time that you no longer wish to receive direct marketing communications

Webb Lawnmowers  
Murdock Road  
Dorcan  
Swindon  
Wiltshire  
SN3 5HY